

Weight (Kg/mt)	Width (mm)	Height (mm)	RTH (C/W)*	*Lenght (mm)
	15			24

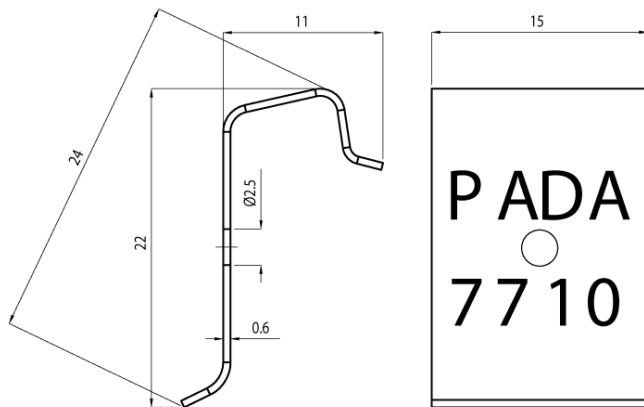

**MOUNTING INSTRUCTIONS**

**PRESSURE ON THE COMPONENT**  
 S=4,0mm F=3,5Kg  
 S=4,5mm F=4,5Kg  
 S=5,0mm F=5,5Kg  
 REMARK: CLIP IS NOT SUITABLE FOR DIFFERENT THICKNESSES.

**MOUNTING FORCE (S=5,0mm)**  
 HORIZONTAL: MAX 25Kg  
 AT 45°: MAX 15Kg  
 REMARK: FORCES ARE TAKEN ON HEAT SINK AT NOMINAL DIMENSIONS

**IMPORTANT REMARK**  
 PRESSURE ON THE COMPONENT COULD CHANGE IF THE POINT OF FORCE MOVES MORE THAN 1 MM AWAY FROM THE CENTRE OF THE COMPONENT.

